



TR20A112-C RE / 04.2013

DE

Anleitung für Montage und Betrieb

Funk-Innentaster FIT 2 BiSecur

EN

Instructions for fitting and operating

Radio internal push button FIT 2 BiSecur

FR

Instructions de montage et d'utilisation

Bouton-poussoir sans fil FIT 2 BiSecur

NL

Handleiding voor montage en bediening

Draadloze drukknopschakelaar FIT 2 BiSecur

IT

Istruzioni per il montaggio e l'uso

Radiotastiera interna FIT 2 BiSecur

ES

Instrucciones de montaje y funcionamiento

Pulsador interior vía radiofrecuencia FIT 2 BiSecur

PT

Instruções de montagem e funcionamento

Interruptor interior de radiofrequência FIT 2 BiSecur



ENGLISH

Contents

1	About these instructions	15
2	Safety instructions	15
2.1	Intended use.....	15
2.2	Safety instructions for operation of the radio internal push button.....	15
3	Scope of delivery	16
4	Description of the radio internal push button FIT 2 BiSecur	17
5	Fitting	17
6	Connection of control elements	19
6.1	Key switches.....	19
7	Initial start-up	20
7.1	Inserting the battery.....	20
8	Operation	20
9	Learning and inheriting / transmitting a radio code	21
9.1	Teaching in a radio code.....	21
9.2	Mixed operation / BiSecur and fixed code 868 MHz	22
10	Reset	22
10.1	Set the fixed code 868 MHz.	22
11	LED display	23
12	Cleaning	23
13	Disposal	23
14	Technical data	24
15	EC Declaration of Conformity	24

Dissemination as well as duplication of this document and the use and communication of its content are prohibited unless explicitly permitted. Noncompliance will result in damage compensation obligations. All rights reserved in the event of patent, utility model or design model registration. Subject to changes.

Dear Customer,

We thank you for choosing a quality product from our company.

1 About these instructions

Read through all of the instructions carefully, as they contain important information about the product. Pay attention to and follow the instructions provided, particularly the safety instructions and warnings.

Further information about handling the radio internal push button can be found on the Internet at **www.hoermann.com**

Please keep these instructions in a safe place and make sure that they are available to all users at all times.

2 Safety instructions

2.1 Intended use

The radio internal push button FIT 2 BiSecur is a unidirectional transmitter for operators and their accessories. It can be operated with both the BiSecur radio and the fixed code 868 MHz.

Other types of application are prohibited. The manufacturer is not liable for damage caused by improper use or incorrect operation.

2.2 Safety instructions for operation of the radio internal push button



WARNING

Danger of injury during door travel

Persons may be injured by door travel if the radio internal push button is actuated.

- ▶ Make sure that the radio internal push buttons are kept away from children and can only be used by people who have been instructed on how the remote-control door functions!
- ▶ If the door has only one safety feature, only operate the radio internal push button if you are within sight of the door!
- ▶ Only drive or pass through remote control door systems if the door is in the Open end-of-travel position!
- ▶ Never stand in the door's area of travel.

 **CAUTION****Danger of injuries due to unintended door travel**

- See warning in section 9

ATTENTION**Malfunction due to environmental influences**

Non-compliance with these instructions can impair function!

Protect the radio internal push button from the following conditions:

- Direct sunlight (permissible ambient temperature: 0°C to +60°C)
- Moisture
- Dust

NOTES:

- If there is no separate garage entrance, perform all programming changes and extensions of radio systems from inside the garage.
- After programming or extending the radio system, perform a function test.
- Only use original components when putting the radio system into service or extending it.
- Local conditions may affect the range of the radio system.
- When used at the same time, GSM 900 mobile phones can affect the range.

3 Scope of delivery

- Radio internal push button FIT 2 BiSecur
- 1 × 3 V battery, type: CR2032
- Fixing material
- Operating instructions

4 Description of the radio internal push button FIT 2 BiSecur

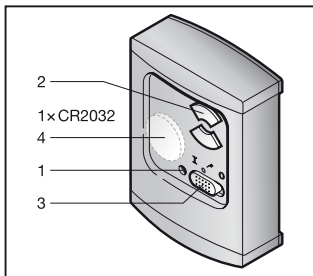

- 1 LED, bi-colour
- 2 Transmitter buttons
- 3 On / off switch for connected control elements
- 4 Battery

5 Fitting

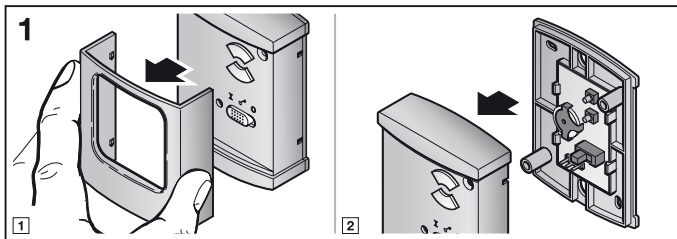

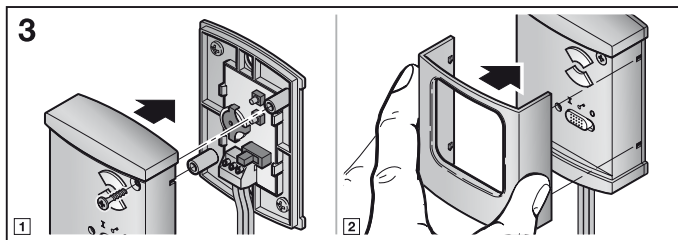
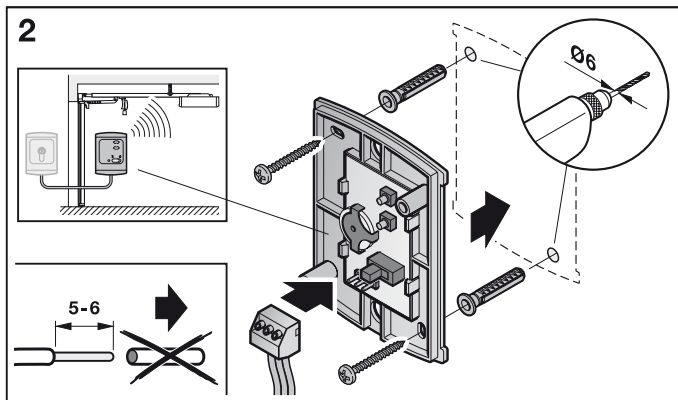

NOTE:

Before fitting the radio internal push button, make sure that the radio code can be received at the desired location. Direct fitting on metal will affect the range. In this case, fit it at a distance of 2-3 cm.

6 Connection of control elements

6.1 Key switches

A key switch can be connected as shown in Figure 4. Here, input E1 corresponds to the top transmitter button and input E2 to the bottom transmitter button. This makes it possible to open and close two garage doors in impulse operation.

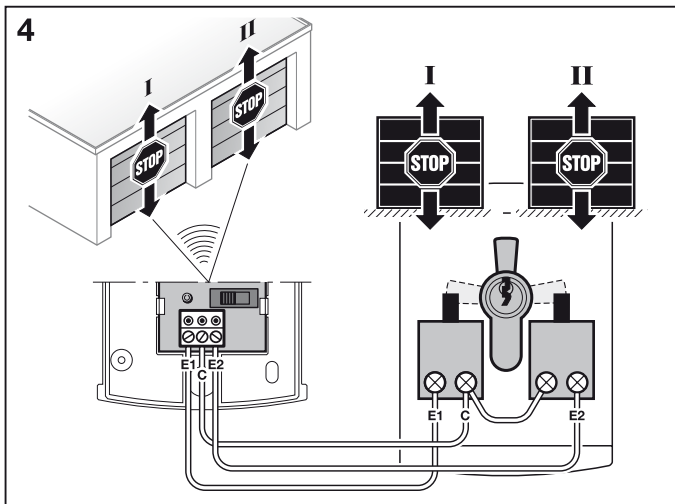

7 Initial start-up

After inserting the battery, the radio internal push button FIT 2 BiSecur is ready for operation.

7.1 Inserting the battery

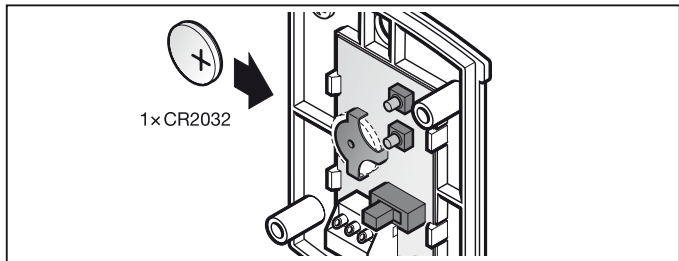

ATTENTION

Destruction of the radio internal push button by leaking batteries

Batteries can leak and destroy the radio internal push button.

- ▶ Remove the battery from the radio internal push button if it is out of use for a long period of time.

8 Operation

NOTE:

If the radio code for the taught-in transmitter button was copied from another hand transmitter beforehand, the transmitter button must be pressed a second time during initial start-up.

Each transmitter button is assigned to a radio code. Press the transmitter button whose radio code you want to transmit.

- The radio code is transmitted and the LED is illuminated blue for 2 seconds.

NOTE:

If the battery is almost empty, the LED flashes red twice

- a. before transmitting the radio code.
 - ▶ The battery **should be** replaced soon.

- b. and the radio code is not transmitted.
 ► The battery **must be** replaced immediately.

The radio codes can also be sent via an extra connected key switch (see section 6.1). This function can be turned off using the on / off switch.

9 Learning and inheriting / transmitting a radio code

⚠ CAUTION

Danger of injuries due to unintended door travel

Unintended door travel may occur while teaching in the radio system.

- Pay attention that no persons or objects are in the door's area of travel when teaching in the radio code.

9.1 Teaching in a radio code

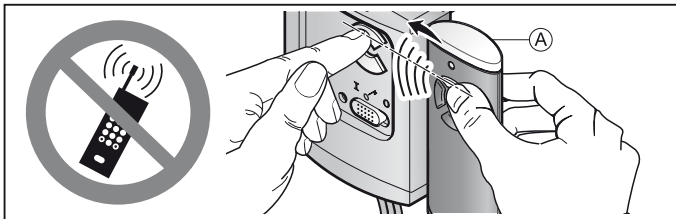

- Press the hand transmitter button on hand transmitter **A**, whose radio code is to be inherited, and keep it pressed.
 - The radio code is transmitted and the LED is illuminated blue for 2 seconds then goes out.
 - After 5 seconds, the LED flashes alternately red and blue, the hand transmitter transmits the radio code.
- Hold the hand transmitter to the right of the radio internal push button.
- Press the transmitter button to which the new radio code is to be allocated, and keep it pressed.
 - The LED will flash slowly in blue.
 - If the radio code is recognised, the LED flashes quickly in blue.
 - After 2 seconds, the LED goes out.

NOTE:

You have 15 seconds to inherit / transmit the code. The process must be repeated if the radio code is not successfully inherited / transmitted within this time.

9.2 Mixed operation / BiSecur and fixed code 868 MHz

If the BiSecur radio has been set, mixed operation is possible, i.e. existing hand transmitters with an 868 MHz fixed code (grey hand transmitters with blue buttons or the device designation HSD2-868) can be taught in from the radio internal push button.

10 Reset

Each transmitter button is assigned to a new radio code by means of the following steps.

1. Open the radio internal push button housing and remove the battery for 10 seconds.
2. Press a transmitter button and keep it pressed.
3. Insert the battery.
 - The LED slowly flashes in blue for 4 seconds.
 - The LED flashes rapidly in blue for 2 seconds.
 - The LED is illuminated blue for a long time.
4. Release the transmitter button.
All radio codes are newly assigned.
5. Close the radio internal push button housing.

NOTE:

If the transmitter button is released prematurely, no new radio codes are assigned.

10.1 Set the fixed code 868 MHz.

If immediately following the device reset, the transmitter button remains pressed, the fixed code 868 MHz will be activated.

- The LED slowly flashes in red for 4 seconds.
- The LED flashes rapidly in red for 2 seconds.
- The LED is illuminated red for a long time.

All radio codes are newly assigned.

NOTE:

If the transmitter button is released prematurely, the BiSecur radio will remain active.

Further information about operating the radio internal push button with the fixed code 868 MHz can be found on the Internet at **www.hoermann.com**

11 LED display

Blue (BU)

Condition	Function
Illuminated for 2 seconds	A radio code is being transmitted
Flashes slowly	Radio internal push button is in the learn mode
Flashes quickly after slow flashing	A valid radio code was detected during the learning run
Flashes slowly for 4 seconds Flashes quickly for 2 seconds Illuminated long	Device reset is being performed or completed

Red (RD)

Condition	Function
Flashes 2x	The battery is almost empty

Blue (BU) and Red (RD)

Condition	Function
Flashing alternately	The radio internal push button is in inherit / transmit mode

12 Cleaning

ATTENTION

Damaging the radio internal push button by faulty cleaning

Cleaning the radio internal push button with unsuitable cleaning agents can damage the surface.

- ▶ Clean the radio internal push button with a clean, soft, damp cloth.

13 Disposal



Electrical and electronic devices, as well as batteries, may not be disposed of in household rubbish. They must be returned to the appropriate recycling facilities.



14 Technical data

Type	Radio internal push button FIT 2 BiSecur
Frequency	868 MHz
Power supply	1× 3 V battery, type: CR2032
Perm. ambient temperature	0°C to +60°C
Protection category	IP 20

15 EC Declaration of Conformity

(as defined in the R&TTE guideline 1999/5/EC)

Herewith the

Company Hörmann KG Verkaufsgesellschaft
Upheider Weg 94-98
D-33803 Steinhagen

declares that this

Device Radio internal push button for operators
and their accessories

Article designation	Type designation
FIT 2 BiSecur	FIT2-868-BS

based on its design and style in the version circulated by it is in accordance with the basic requirements and other relevant requirements of the directive 1999/5/EC.

Any modification made to this device without our express permission and approval shall render this declaration null and void.

Applied and consulted standards and specifications:

EN 60950-1
EN 300 220-1
EN 300 220-2
EN 301 489-1
EN 301 489-3

This device may be operated in all EU nations, Norway, Switzerland and other countries.

Steinhagen, 21.02.2012



ppa. Axel Becker, Management